

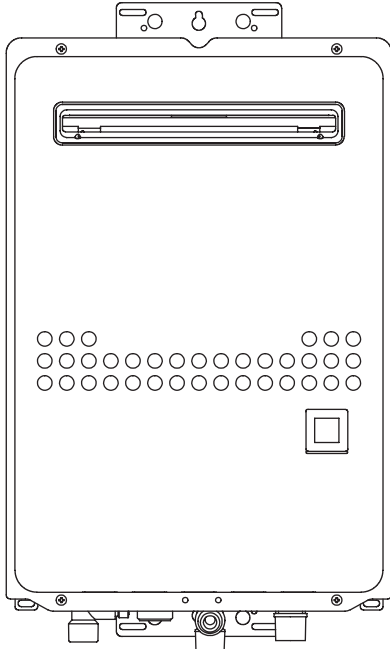

Owner's Guide



(e.g. 26ENG5N)

Non Condensing Models

26ENG5N
26ENG5L
26ENG6N
26ENG6L
21ENB5N
21ENB5L
21ENB6N
21ENB6L
17ENB5N
17ENB5L
17ENB6N
17ENB6L

⚠ WARNING

FOR CONTINUED SAFETY OF THIS APPLIANCE IT MUST BE INSTALLED, OPERATED AND MAINTAINED IN ACCORDANCE WITH THE MANUFACTURER'S INSTRUCTIONS.

Thank you for purchasing this Dux Gas Water Heater.

Before using, please:

Read this manual completely for operating instructions.

Confirm warranty and proof of purchase.

Keep this manual where it can be found whenever necessary.

Installation must conform with Plumbing Code of Australia (PCA) and local codes, or in the absence of local codes, AS/NZS 5601, AS/NZS 3500.4, AS/NZS 3000 wiring regulations and all Local Building, Water and Gas fitting regulations.

Dux reserves the right to discontinue, or change at any time, the designs and/or specifications of its products without notice.

* Note: This appliance requires a minimum flow rate to operate of 1.5-2.5 litres/min., water fixtures with a flow rate of 7.5 litres/min. or higher are recommended.

For optimum performance we recommend installation of Dux optional temperature controllers.



Important Safety Information

WARNING

If the information in this manual is not followed exactly, a fire or explosion may result causing property damage, personal injury or death.

- Do not store or use petrol or other flammable vapours and liquids in the vicinity of this or any other appliance.
- **WHAT TO DO IF YOU SMELL GAS**
 - Do not try to light the appliance.
 - Do not touch any electrical switches; Do not use electrical appliances, including the phone" inside the building.
 - Immediately call your gas supplier, from a safe distance from the gas leak.
- **DO NOT SPRAY AEROSOLS IN THE VICINITY OF THIS APPLIANCE WHILE IT IS IN OPERATION.**
- **DO NOT PLACE ARTICLES ON OR AGAINST THIS APPLIANCE.**
- **DO NOT MODIFY THIS APPLIANCE.**
- This appliance is not intended for use by persons (including children) with reduced physical, sensory or mental capabilities, or lack of experience and knowledge, unless they have been given supervision or instruction concerning use of the appliance by a person responsible for their safety.
- To prevent injury or death, do not allow small children to bathe or play in the bathroom unsupervised.
- This appliance is not suitable for use as a pool heater.
- **DO NOT USE OR STORE FLAMMABLE MATERIALS IN OR NEAR THIS APPLIANCE.**
- Installation and service must be performed by a qualified installer, service agency or the gas supplier.

To prevent damage to property and injury to the user, the icons shown below will be used to warn of varying levels of danger.

Every indication is critical to the safe operation of the Water Heater and must be understood and observed. Potential dangers from accidents during installation and use are divided into the following four categories. Closely observe these warnings; they are critical to your safety.

Icons warning of risk level



This is the safety alert symbol. It is used to alert you to potential personal injury hazards. Obey all safety messages that follow this symbol to avoid possible injury or death.



Indicates an imminently hazardous situation which, if not avoided, will result in death or serious injury.



Indicates a potentially hazardous situation which, if not avoided, could result in death or serious injury.



Indicates a potentially hazardous situation which, if not avoided, may result in minor or moderate injury.



Indicates a potentially hazardous situation which, if not avoided, may result in property damage.

⚠ DANGER

Vapours from flammable liquids will explode and catch fire causing death or severe burns.

Do not use or store flammable products such as petrol, solvents or adhesives in the same room or area near the Water Heater.



Hot Water Heater temperatures over 50°C can cause severe burns instantly or death from scalding.

Children, disabled and elderly are at the highest risk of being scalded. Feel water temperature before bathing or showering. Temperature limiting valves are available, ask licensed installer.

Keep flammable products:

1. Far away from the Water Heater.
2. In approved containers.
3. Tightly closed.
4. Out of children's reach.

Vapours:

1. Cannot be seen.
2. Vapours are heavier than air.
3. Go a long way on the floor.
4. Can be carried from other rooms to the main burner by air currents.

Do Not Install Indoors.

This will cause carbon monoxide poisoning and a potential fire hazard.

⚠ WARNING

A. This Water Heater does not have a pilot. It is equipped with an ignition device that automatically lights the burner. Do not try to light the burner by hand.

B. BEFORE OPERATING smell all around the Water Heater area for evidence of leaking gas. Be sure to smell next to the floor because some gas is heavier than air and will settle on the floor.

WHAT TO DO IF YOU SMELL GAS

- Do not try to light any appliance.
- Do not touch any electrical switch; do not use any phone in your building.
- Immediately call your gas supplier.

Follow the gas supplier's instructions.

C. Use only your hand to turn the gas valve knob. Never use tools. If the knob will not turn by hand, don't try to repair it. Call a qualified service technician. Force or attempted repair may result in a fire or explosion.

D. Do not use this Water Heater if any part has been under water. Immediately call a qualified service technician to inspect the Water Heater and to replace any damaged parts.

When a gas leak is noticed:

1. Stop use immediately.
2. Close the gas valve.
3. Contact your gas supplier immediately.

If you detect abnormal combustion or abnormal odours, or during an earthquake, tornado or fire:

1. Turn off the hot water supply.
2. Turn off the power to the Water Heater.
3. Turn off gas and water supply valves.
4. Call Dux on AU 1300 365 115.

Check the temperature of the running hot water before entering the shower.

Check the temperature before stepping into the bath.

To prevent burns or scalding, turn off the Operation button and wait until the appliance cools before performing maintenance.

Do not install this Water Heater in a mobile home, recreational vehicle or on a boat as this may be a Carbon Monoxide Poisoning Hazard.

⚠ WARNING

Leave the proper clearance between the Water Heater and nearby objects (trees, timber, boxes with flammable materials, etc.).

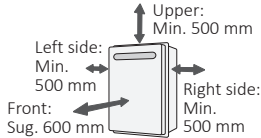

Do not place combustibles such as laundry, newspapers, oils etc. near the Water Heater.

Do not use combustible chemicals such as oil, petrol, benzene etc. in the near the Water Heater or the exhaust vent.

Do not store or use petrol or other flammable vapours and liquids in the vicinity of this or any other appliance.

Do not place or use a spray can near the Water Heater or the exhaust vent.

Do not place the Water Heater in an indoor environment by means of adding walls and ceiling (Do not enclose using corrugated sheets, etc.).

Carbon monoxide poisoning or fire may occur as a result.

Installation and service must be performed by a qualified installer, service agency or the gas supplier.

Do not use hair spray or spray detergent in the vicinity of the Water Heater.

Check that the data plate.

(e.g. For Natural Gas)

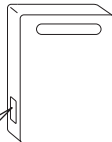

MODEL	XXXXXXXX
GAS TYPE	: NG
GAS CONSUMPTION	: xx MJ/hr
HEAT OUTPUT	: xx kW
ELECTRICAL RATING	: AC230-240V 50Hz
RATED POWER	: xx W
HOT WATER SUPPLY CAPACITY	: xxL/min RAISED xx°C
GAS PRESSURE TEST POINT	

Do not install in locations where excessive dust or debris will be in the air.

To prevent injury or death, do not allow small children to bathe or play in the bathroom unsupervised.

This appliance is not intended for use by persons (including children) with reduced physical, sensory or mental capabilities, or lack of experience and knowledge, unless they have been given supervision or instruction concerning use of the appliance by a person responsible for their safety.

Do not touch the power cord with wet hands.



Contact a qualified service technician for any necessary repairs, service or maintenance.

Do not use parts other than those specified for this appliance.

If the appliance delivers water in excess of 50 Degrees, the following warning must be adhered to:

THIS APPLIANCE MAY DELIVER WATER AT HIGH TEMPERATURE. REFER TO THE PLUMBING CODE OF AUSTRALIA (PCA), LOCAL REQUIREMENTS AND INSTALLATION INSTRUCTIONS TO DETERMINE IF ADDITIONAL DELIVERY TEMPERATURE CONTROL IS REQUIRED.

If the appliance is 50 degree locked model, the following statement & warning must be adhered to:

THIS APPLIANCE DELIVERS WATER NOT EXCEEDING 50 C IN ACCORDANCE WITH AS 3498.

WARNING — THIS APPLIANCE MUST ONLY BE INSTALLED IN ACCORDANCE WITH THE ACCEPTABLE PLUMBING CONFIGURATIONS SPECIFIED IN THESE INSTRUCTIONS. FAILURE TO DO SO MAY RESULT IN CONDITIONS WHERE DELIVERY TEMPERATURE CONTROL IS INADEQUATE.

⚠ CAUTION

Do not use the Water Heater for other than hot water supply, shower and bath.

Do not cover the Water Heater, store trash or debris near it, or in any way block the flow of fresh air to the appliance.

Do not use condensate, discharged from the condensate drain pipe, for drinking or for consumption by animals.

Do not touch the exhaust vent during or immediately after operation of the Water Heater.

Be sure to electrically earth the appliance.

Keep power cord free of dust.

Do not use a broken or modified power cord. Do not bind, bend or stretch power cords. Do not scratch, modify, or subject them to impact or force. If the supply cord is damaged, it must be replaced by the manufacturer, its service agent or similarly qualified persons in order to avoid a hazard.

Do not turn off the Water Heater while someone is bathing.

Do not exchange a remote controller cord without notice.

NOTICE

Do not drink water that has been inside the appliance for an extended period of time. Do not drink the first use of hot water from the appliance in the morning.

Clean the filter on the water inlet as frequently as required. The quality of your local water will affect the frequency required.

Keep the area around the appliance clean. If boxes, weeds, cobwebs, cockroaches etc. are in the vicinity of the appliance, damage or fire can result.

Do not install the appliance where the exhaust will blow on walls or windows.

Treat hard, acidic or otherwise impure supply water with approved methods to ensure full warranty coverage.

Problems resulting from scale formation are not covered by the warranty.

Do not run water through the appliance when appliance is not on. When discharging hot water, make sure the appliance is ON. If water is run through the appliance with the appliance OFF, water may condense inside the appliance and cause incomplete combustion or damage to the internal electrical components.

Contact Dux before using with a solar heater.

Do not disassemble the Remote Controller.

Do not use chlorine-based, acidic, alkaline detergents, organic solvents such as benzene and thinner, or Melamine Sponge to clean the Remote Controller.

This may cause discolouration, deformation, scratches or cracks.

Do not get the Remote Controller wet. ECB1D and ECB2D are water resistant, too much water can cause damage. ECM1D is not water resistant.

Do not splash water on the Remote Controller.

Do not expose the Remote Controller to steam.

Although it is water resistant, too much water can cause damage.

Do not locate the Remote Controller near stoves or ovens.

This may cause damage or failure.

Preventing damage from freezing (See page 17)

- Damage can occur from frozen water within the appliance and pipes even in warm environments. Be sure to read below for appropriate measures.
- Repairs for damage caused by freezing are not covered by the warranty.

Power must be switched on at all times for antifrost protection to work.

If it is snowing, check the air inlet, exhaust gas vent and exhaust vent terminal for blockage.



Contents

Important Safety Information	2
Contents	6
General	7
Names and Functions of Controllers	
Main Controller (ECM1D), Bathroom Controller (ECB1D)	8
Bathroom 2 Controller (ECB2D)	9
Initial Operation	10
Clock Adjustment	11
Setting and Using the Water Heater	
Operation (Not using the Remote Controller)	12
Operation (Using the optional Remote Controller)	13
Controller Priority Function	14
Customizable Settings	
Muting the Remote Controller	15
Bath Fill Function	15
Call Function	16
Frost Protection	17
Regular Maintenance	19
Troubleshooting	21
Follow-up Service	24
Specifications	25
Maintenance	26
Manufacturer's Warranty	28

General

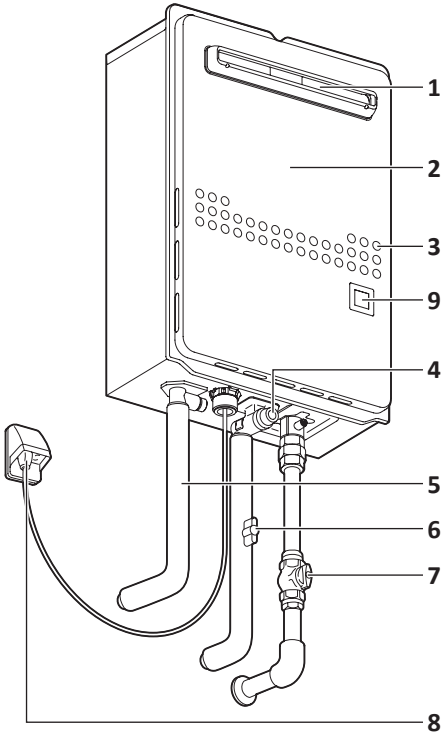

(e.g. 26ENG5N)

This illustration shows an example of installation. The exact installation configuration may be slightly different.

1. Flue Exhaust

2. Front Cover

3. Air Inlet

4. Inlet water filter

Inside Water Inlet (See page 20)

5. Hot Water Pipe

6. Water Supply Valve

7. Gas Supply Valve

8. External Weatherproof Power Point

9. (26ENG series only) Status Display

Indicate the status of Water Heater or error codes.



When water heater is initially plugged into power, set temperature is displayed for approx. thirty seconds.

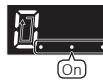

When water is flowing, the bar rotates clockwise. When the gas burner is on, three dots are displayed.



If the bar rotates slowly while blinking, that means that water flow rate is insufficient to turn on the burner.



When the gas burner is on, set temperature is displayed for a minute and then "on" is displayed.



If an error has occurred, a blinking error code is displayed.

NOTE (For 26ENG series)

When using without remote controller, check the set temperature shown on the Status Display before use.

Names and Functions of Controllers

Main Controller (ECM1D), Bathroom Controller (ECB1D) <Optional>

- What is actually displayed depends on how the Water Heater is set.
- Before use, remove the protective sheet from the Remote Controller surface.

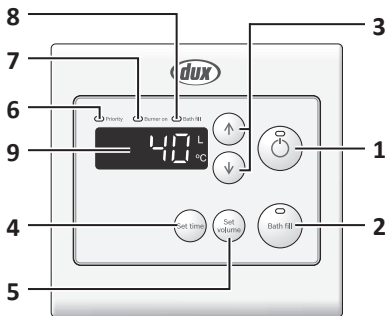

(ECM1D)

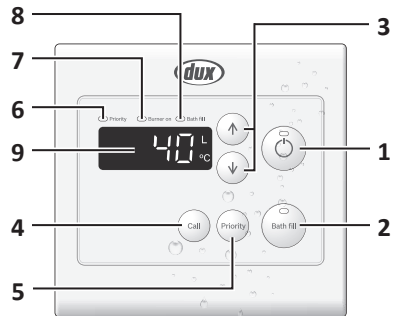

(ECB1D)

1. Operation Button / Indicator

For turning the Water Heater ON/OFF.

2. Bath Fill Button / Indicator

To activate Bath Fill. To set Bath Fill temperature. (See page 15)

3. Setting Buttons

For setting the hot water temperature and other settings.

4. • (For ECM1D) Set time Button

To set or indicate time of day. (See page 11)

• (For ECB1D) Call Button

To sound alarm at all remote controls. (See page 16)

5. • (For ECM1D) Set volume Button

For setting the amount of water that is delivered. (See page 15)

• (For ECB1D) Priority Button

To transfer control from another remote. (See page 14)

6. Priority Indicator

When this indicator is displayed, the hot water temperature can be set. (See page 14)

7. Burner on Indicator

When burning, the indicator is displayed.

8. Bath Fill Temperature Indicator

When this indicator is displayed, bath fill temperature is displayed. (See page 15)

9. • Temperature setting (e.g. 40°C)

• Bath Fill Temperature setting (e.g. 40°C)

• Bath Fill Volume setting (See page 15)

• (For ECM1D only) Clock

When Set time button is pressed, the clock is displayed. (See page 11)

• Error Code

A number will flash if a failure occurs. (See page 23)

Bathroom 2 Controller (ECB2D) <Optional>

- What is actually displayed depends on how the Water Heater is set.
- Before use, remove the protective sheet from the Remote Controller surface.

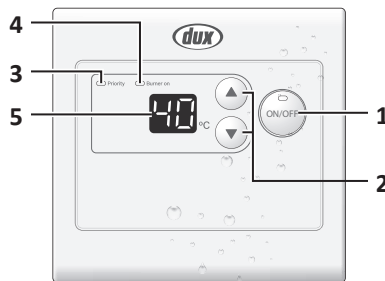

1. Operation Button / Indicator

For turning the Water Heater ON/OFF.

2. Setting Buttons

For setting the hot water temperature. (See page 13)

3. Priority Indicator

When this indicator is displayed, the hot water temperature can be set. (See page 14)

4. Burner on Indicator

When burning, the indicator is displayed.

5. • Temperature setting (e.g. 40°C)

• Error Code

A number will flash if a failure occurs. (See page 23)

Initial Operation

Before start using for the first time, do the following:

1. Open the water supply valve.

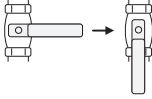

2. Open a hot water fixture to confirm that water is available, and then close the fixture again.

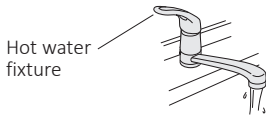

3. Open the gas supply valve.

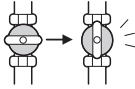

4. Turn on the power.

Clock Adjustment *(For Main Controller only)*

Clock setting and the clock can be displayed regardless of "ON or OFF" of the operation button. (The illustration is in a state of "OFF".)

Operation

1. Press the **Set time** button until "0:00" is flashing.

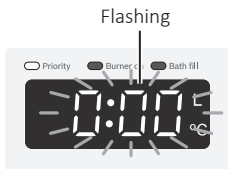

2. Adjust the clock using the \uparrow/\downarrow buttons.

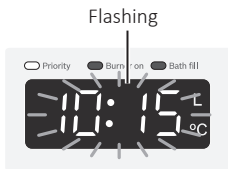

- The time changes in 1-minute increments with each press on the button, and then in 10-minute increments if the button is kept pressed down.

3. Press the **Set time** button.

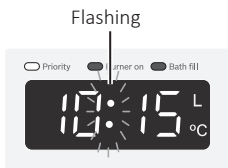

- The flashing changes to constant illumination when the clock has been set.

Display the clock

1. Press the **Set time** button.

- The clock display will then return to the original screen display.

- NOTE**
- The clock display will disappear if hot water is used or the temperature of the hot water is changed during the clock display.
 - If the Time set button is pushed when the hot water is being used or a high temperature (60°C or more) is set, the clock is displayed for 10 seconds and will return to the original screen display after that.
 - In the event of a power cut or after disconnecting the power supply, the clock on the display screen will show 0:00 when the power is restored. In this case the clock will need to be reset.

Setting and Using the Water Heater

⚠ DANGER

- **To prevent scalding :**
Hot Water Heater temperatures over 50°C can cause severe burns instantly or death from scalding.
- Children, disabled people and elderly are at the highest risk of being scalded. Please check the water temperature before bathing or showering.
Temperature limiting valves are available, ask licensed installer.
- When setting the Water Heater to 60°C or higher, the temperature display will blink for 10 seconds.
- Take caution when using the Water Heater again after setting to 50°C or higher. Always check the set temperature before use.

Operation (Not using the Remote Controller)

The factory temperature setting is 50°C (for 50 degree models) or 55°C (for other than 50 degree models). Mix with cold water with a mixing valve or at the fixture for desired temperature.

1. Check that electrical power is connected.
 - How to check the set temperature. If the power supply is set to "OFF", and then set to "ON", the temperature of supplied hot water is displayed.



(Status Display)

- Set temperature is displayed.
* When unit is initially plugged into power.

2. Turn on hot water.



Indicates the burner is on.

- The outside edge of the 2 digit display will rotate in a circular pattern. If the amount of water is too low, "L" will be indicated.

3. Mix for demand temperature.
4. Turn off the hot water.



Indicates the burner is off.

- The electrical power does not need to be disconnected every time after using.

Operation (Using the optional Remote Controller)

1. The **Operation** button is ON.

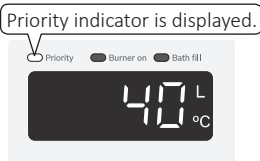

(e.g. 40°C)

- The Operation indicator is displayed.
- The previously set hot water supply temperature is shown.

2. Set the temperature using the **↑/↓** buttons.

- NOTE**
- Check the temperature displayed before using any hot water. Be especially careful using hot water after the set temperature has been changed.
 - For most residential applications, the recommended setting temperature is 50°C or less. For applications that occasionally require a higher temperature setting, locate the remote controller in a convenient location.
 - While using hot water, the set temperature can be lowered to minimum of 37°C. For safety, it cannot be raised above 43°C until all hot water taps are closed. (For some products)

3. Turn on hot water.

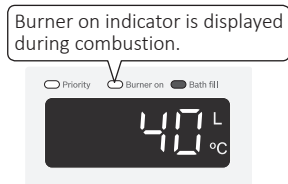

Burner on indicator is displayed during combustion.

- Turn off hot water, the Burner on indicator disappears.

Temperature Setting Options

The temperature settings below are examples. The temperature setting necessary depends on the usage, the length of piping and the season.

(Default setting is 40°C)

37°C	Washing dishes, etc.	
38°C		
39°C	Shower, hot water supply, etc.	(Bathroom and Bathroom 2 controller are these ranges.)
40°C		
41°C		
42°C		
43°C		
44°C	Hot water supply, etc.	[50 degree models: Main and Bathroom and Bathroom 2 controller are these ranges.]
45°C		
46°C		
47°C		
48°C		
50°C		
55°C		
60°C	High temperature*2	
70°C *1		

*1 26ENG series only

*2 Display when high temperature is set



(e.g. 60°C)

Flashing for 10 seconds

- NOTE** If the set temperature requires frequent adjustment, locate the Remote Controller in an easily accessible location.

Controller Priority Function

Hot water supplied from this Water Heater is delivered to the kitchen, bathroom, and shower, etc. at the same temperature.

The water temperature can only be changed by one remote controller if multiple remote controllers are installed.

Only the controller with the priority light illuminated will be able to adjust the temperature of the Water Heater.

- The remote controller on which the operation button is turned "ON" has priority.
- If the Bathroom or Bathroom 2 controller has priority left ON, press OFF and ON any other controller to transfer priority to that controller. This function cannot be changed while the Water Heater is producing hot water.

Operation

When the temperature cannot be adjusted, follow the procedure below.

For Bathroom Controller

1. Press and hold the **Priority** button.

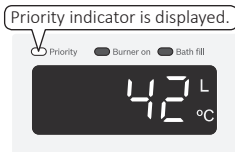

For Main Controller and Bathroom 2 Controller

1. Turn off the **Operation** button.
 - The Operation indicator disappears.

NOTE Operation will be interrupted so please be careful.
2. Turn on the **Operation** button once again.

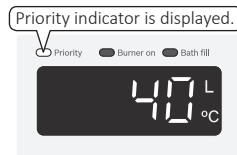

(e.g. ECM1D)

- The Operation indicator is displayed.

Customizable Settings

Muting the Remote Controller

The Remote Controller will emit a sound when any button is pressed. This sound can be muted if needed.

Operation

1. Press and hold the **Operation** button for 5 seconds.

[Muted]
No sound after 5 seconds
[Sound ON]
Sounds after 5 seconds

(Default setting = Sound ON)

- The bath fill and the call function alarm cannot be muted.

Bath Fill Function

When the bath has reached the volume set on the controller, an alarm sounds and the hot water supply will stop automatically.

Operation

1. The **Operation** button is ON.

2. Press the **Bath fill** button.

- The bath fill temperature will flash. After 10 seconds, it will be displayed.

3. Set the temperature using the **↑/↓** buttons.

- Check the current setting temperature.

4. Press the **Set volume** button, and adjust with the **↑/↓** buttons.

- The bath fill volume setting will flash.

40- 80 L (In 20 L intervals),
120- 200 L (In 40 L intervals),
250- 650 L (In 50 L intervals)

(Default setting = 160 L)

- * Bath fill volume options may change depending on the continuous flow models.
- The level can only be adjusted while the bath fill volume setting is flashing.
- After 10 seconds, the Remote Controller will again display the temperature.
- (For Bathroom controller) To alter the bath fill volume press the **Priority** button after the **Bath fill** button.

5. Turn on hot water.

- When the bath fills with the preset volume of water, the water will stop and an alarm will sound.

6. Turn off the hot water when the alarm sounds.

- When using hot water at another hot water outlet, also turn it off.
- [When you turn off the hot water supply] Bath fill temperature indicator turns off. (within approx. 1 minute)
- [If you do not turn off the hot water supply] The equipment automatically runs the water to check if the hot water supply has been turned off.
- [When approx. 10 minutes passes without turning off the hot water supply the sound is played] The screen "oFF" appears, so turn off all the hot water supplies and then press the **Bath fill** button.
- The setting temperature becomes the bath fill temperature after the bath fill was used.
- Button operation may not be accepted at the end of bath fill.

Call Function *(For Bathroom Controller only)*

The call button can be used to sound an alarm at the Main Controller.

Operation

1. Press the **Call** button.
 - The alarm sounds for as long as the button is pressed.
 - The **Call** button can be used regardless of whether the **Operation** button is turned “on” or “off”.

Frost Protection

NOTICE

- Damage can occur from frozen water within the appliance and pipes even in warm environments. Be sure to read below for appropriate measures.
- Repairs for damage caused by freezing are not covered by the warranty.

Freezing is prevented within the device automatically by the freeze prevention heater.

Freezing cannot be prevented when the power plug is unplugged. Do not remove the power plug from the wall outlet.

Freezing will be prevented regardless of whether the **Operation** button is ON or OFF.

The freeze prevention heaters will not prevent the plumbing external to the Water Heater from freezing. Protect this plumbing with insulation, heat tape or electric heaters, solenoids, or pipe covers.

Take the measures below for extremely cold temperatures*.

* Outside temperature including wind chill factor less than -15°C.

This method can protect not only the Water Heater, but also the water supply, water piping and mixing valves.

1. Turn off the **Operation** button.
2. Close the gas supply valve.
3. Open a hot water fixture, and keep a small stream of hot water running. (400 mL/minute or about 4 mm thick.)
 - If there is a mixing valve, set it to the highest level.

Hot water fixture

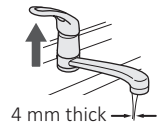

4. The flow may become unstable from time to time. Check the flow 30 minutes later.
 - In general, it is not advisable to run water through the Water Heater when it is OFF (See page 5), but in this case freeze prevention is more important.

If water will not flow due to freeze

1. Close the gas and water valves.
2. Turn off the **Operation** button.
3. Open the water supply valve occasionally to check whether water is running.
4. When the water is flowing again, check for water leaks from the Water Heater and piping before using.

NOTE If the Water Heater or the piping is frozen, do not use the Water Heater or it may get damaged.

If the water heater will not be used for a long period of time, drain the water.

CAUTION

To avoid burns, wait until the equipment cools down before draining the water. The appliance will remain hot after it is turned off.

- To prevent damage from freezing, the water heater must be plugged into power at all times. If power is unplugged, drain the water completely from the water heater. Then use an air compressor to remove all water from inside the unit's water piping. It is recommended that Isolation Valves are installed on the water heater, otherwise the water connections will need to be removed to drain the unit completely. Freeze damage due to not draining properly will not be covered under warranty.
- Drain water into a bucket to prevent water damage.

1. Close the gas supply valve.

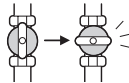

2. Turn and leave open the hot water fixtures for more than 2 minutes and close.

* When the remote controller is installed, set "Operation Button ON". Turn and leave open the hot water fixtures for more than 2 minutes and close.

Hot water fixture

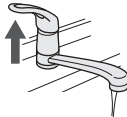

(An 11 Error Code may appear on the remote controller. This is not a malfunction of the unit. Do not turn Operation Button OFF.)

3. Close the water supply valve and disconnect the electrical power supplied to the unit.

Do not touch with wet hands.

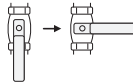

4. Fully open all hot water fixtures.

Hot water fixture

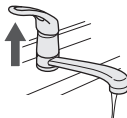

5. Open all drain plugs and drain the water out of the unit.
6. When the water is completely drained, replace all drain plugs and close the hot water fixtures.

(26ENG series)

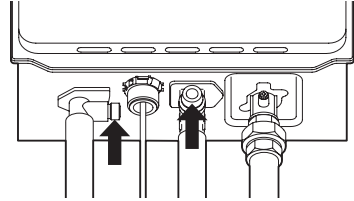

(17/21ENB series)

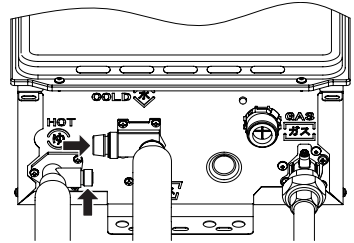

Drain Plugs: Each drain plug might not be visible if insulation is installed around the piping.

Turning the Unit Back On

1. Check that all drain plugs are inserted.
2. Check that all hot water fixtures are closed.
3. Follow the procedure on page 10 "Initial operation", steps 1 through 4.

* If water does not appear at the end of the drain line, a qualified service technician must clean the condensate line.

Regular Maintenance

Periodic Inspection

This Water Heater should be serviced by an authorised person at regular intervals not exceeding 2 years.

⚠ WARNING

To prevent burns or scalding, turn off the **Operation** button and wait until the appliance cools before performing maintenance.

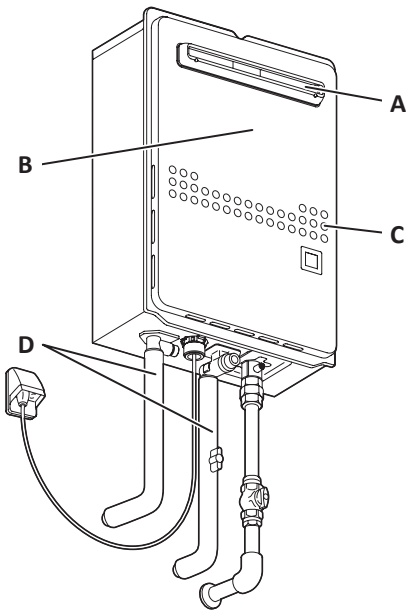

(e.g. 26ENG5N)

Check : A

For dust and soot in the flue exhaust.

Check : B

- For abnormal sounds during operation.
- For abnormalities in external appearance, discolouration or flaws.

Check : C

For dust or debris in the air inlet.

Check : D

For water leaks from the Water Heater and piping.

Check

For laundry, newspaper, timber, oil, spray cans and other combustible materials near the Water Heater.

Periodic Maintenance

Water Heater

Wipe the outside surface with a wet cloth, then dry the surface. Use a neutral detergent to clean any stains.

Remote Controller

Wipe the surface with a wet cloth.

- NOTE**
- Do not use chlorine-based, acidic, alkaline detergents, organic solvents such as benzene and thinner, or Melamine Sponge to clean the Remote Controller; discolouration, deformation, scratches or cracks may occur.
 - ECB1D and ECB2D are water resistant but not water proof. Keep it as dry as possible. ECM1D is not water resistant.

Inlet water filter

If the inlet water filter is covered with debris, the hot water may not run smoothly, or the Water Heater may put out cold water. Check and clean the filter as explained below.

⚠ WARNING

To prevent burns or scalding, turn off the **Operation** button and wait until the appliance cools before draining the water.

1. Close the water supply valve.

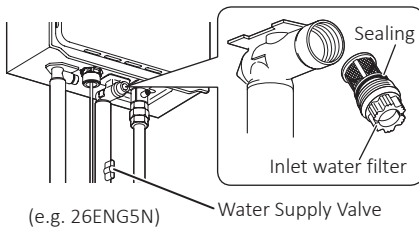

2. Open all hot water fixtures.
3. With a bucket ready, remove the inlet water filter. (about 1 L will drain out)
4. Clean the inlet water filter with a brush under running water.
5. Reattach and close inlet water filter.

NOTE Do not lose the Sealing.

6. Close all hot water fixtures.
7. Open the water supply valve and check that water does not leak from the inlet water filter.

Troubleshooting

Initial Operation

The Water Heater does not attempt to ignite when water is running.

- Check for reversed plumbing or crossed pipes.
- Check the inlet water filter. (See page 20)

The Water Heater attempts to ignite but fails.

- Reset the Water Heater and try again. There may be air in the gas pipe.
- Check the gas supply pressure with a professional.

Remote Controller

The Operation indicator does not light up.

- Has there been a power failure?
- Is the power connected properly?

Clock shows "0:00".

- When the power is reconnected, the clock on the display screen shows "0:00". In this case, clock setting need to be reset. (See page 11).

The water temperature changes after a power failure or when the power is disconnected.

- The temperature setting and the bath fill setting may both need to be reset after a power outage.

The plastic on the surface or buttons of the Remote Controller has torn, peeled, or air bubbles inside.

- The surface of the Remote Controller is affixed with a protective sheet (to prevent surface scratching, etc.) at time of shipment. This sheet can be removed or left as it is. When leaving the protective sheet on, areas frequently touched may tear or peel. However, the Remote Controller will not malfunction from water entering such torn or peeled areas. To restore the appearance of the Remote Controller surface, simply remove the protective sheet.

Temperature

No water is available when a fixture is opened.

- Is the water supply cut off?
- Is the Water Heater frozen?

Hot water is not available when a fixture is opened.

- Are the gas and water supply valves fully open?
- Is the water supply cut off?
- Is the hot water fixture sufficiently open?
- Is the gas being cut off by the gas meter? (Can other gas devices such as stoves be used?)
- (For ULPG) Is there enough gas in the tank? (Can other gas devices such as stoves be used?)
- Is the inlet water filter clogged? (See page 20)
- Is the Operation button turned ON?

The hot water is not the correct temperature.

- Is the hot water fixture sufficiently open?

The bath fill water is not the setting temperature.

- If there was water in the bath already when the bath fill begin, the temperature in the bath may be different from the temperature setting.

Water takes time to become hot when turning the hot water fixture.

- Have you allowed enough time for the cold water in the pipes to drain out?

The water is too hot.

- Are the gas and water supply valves fully open?
- Is the water temperature setting appropriate? (See page 13)
- If the water supply temperature is high, it is possible for the temperature to be higher than the temperature set on the Remote Controller.
- If only a small amount of hot water is demanded, it is possible for the temperature to be higher than the temperature set on the Remote Controller.

The water is not hot enough.

- Are the gas and water supply valves fully open?
- Is the water temperature setting appropriate? (See page 13)

The water is cold when only a single fixture is open.

- The unit will not heat the water if the flow rate is low.
 - 26ENG series: less than 1.5 L/min
 - 21/17ENB series: less than 2.5 L/min
- Open the fixture more or open other fixtures so that a greater flow passes through the unit, and the unit should begin heating again.



Fluctuations in hot water temperatures.

- Set water temperature at 48°C to 50°C. This will allow you to use a higher flow of hot water than meeting the minimum flow requirement*.
 - * 26ENG series: 1.5 L/min
 - 21/17ENB series: 2.5 L/min
- Clean the inlet water filter of any debris (See page 20)

Amount of Hot Water**The amount of hot water at a certain fixture is not constant.**

- When hot water is demanded at other fixtures, the amount available may be reduced.

The maximum flow available from a 26 litre model is 26L/min, from a 21 litre model is 21 L / min, from a 17 litre model is 17 L /min at a 25°C temperature rise.
- Pressure fluctuations and other plumbing conditions can cause the temperature and pressure at a fixture to be unstable, but it should stabilize after a short time.
- There are some types of hot water taps that discharges large volumes of hot water at first but stabilize after time.
- To keep the temperature stable, the Water Heater limits the amount of water that can flow through it to a small amount initially, but the amount increases over time.

The amount of hot water in the bath is less/more than the set amount.

- When hot water is used for other fixtures while filling the bath, the bath will not fill as much.
- If there is water in the bath already, or when filling is stopped and restarted, the bath will fill more.

The bath fill alarm does not sound even when filled to the set amount.

- The bath fill alarm is set to sound when hot water is continuously discharged for the set volume of water.

If mixing valves are used, or if cold water is mixed with hot water at the fixture, the bath will fill more than the setting of the bath fill function.

Amount of hot water available has decreased over time.

- Is the inlet water filter clogged? (See page 20)

Sounds**The fan can be heard after operation is stopped. A motor can be heard when turning the Water Heater on or off, when opening or closing a fixture, or after the Water Heater has been running for a while.**

- These noises indicate the proper operation of devices which are designed to let the Water Heater reignite more quickly, and ensure the water temperature is stable.

Other**The Water Heater stops burning during operation.**

- Are the gas and water supply valves fully open?
- Is the water supply cut off?
- Is the hot water fixture sufficiently open?
- Is the gas being cut off by the gas meter? (Can other gas devices such as stoves be used?)
- (For ULPG) Is there enough gas in the tank? (Can other gas devices such as stoves be used?)

White smoke comes out of the flue exhaust on a cold day.

- This is normal. The white smoke is actually steam.

The hot water is turbid.

- This is harmless. Small bubbles appear as the air in the water is heated and depressurized rapidly to atmospheric pressure.

The water appears blue.**The bath/wash-basin has turned blue.**

- Colouration to a blue colour may be noticed from small traces of copper ion contained in the water and fat (furring). However, there are not problems concerning health. Colouration of the bath/wash-basin can be prevented by cleaning frequently.

A small amount of water is discharged from the pressure relief valve.

- This is normal. When the Water Heater is under high pressure, a small amount of water may be discharged from the pressure relief valve.

Check for an Error Code

When a failure occurs, information relating to the error flashes on the Status Display or optional Remote Controller. At the same time, a buzzer will be used. To stop the buzzer sound, the Operation button must be turned off.

If this occurs, take appropriate measures as the following list.



Status Display

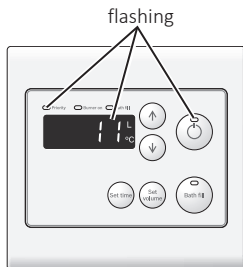

Main Controller

Error Code : 11

Cause : Ignition failure

Action : Check whether the gas valve is open. Press the **Operation** button to turn the Water Heater off, open a hot water fixture, and turn the Water Heater back on. In this error code, you may be able to clear the error code simply by turning the hot water fixture OFF, then ON again. If the blinking number doesn't return the problem is solved.

Error Code : (On the Status Display) 901, 903, 908 (On the Remote Controller) 90

Cause : Abnormal combustion

Action : If the display continues, contact the installer or Dux Service Department for assistance.

Error Code : (On the Status Display) 902 (On the Remote Controller) 90

Cause : Abnormal combustion, low gas supply pressure.

Action : Have a professional check the gas supply pressure. Contact the installer or Dux Service Department for assistance.

Error Code : 99

Cause : Abnormal combustion

Action : Contact the installer or Dux Service Department for assistance.

Indication on the Status Display :

Cause : "Lo" means that the water flow is under minimum operating water flow and is insufficient to turn on the burner.

Indication on the Status Display :



Cause : "L1", "L2" or "L3" means that water flow rate is more than minimum operating flow, but is insufficient to turn on the burner because of high temperature of inlet water. This continues to be displayed for an hour after closing the tap.

Indication on the Status Display :

Cause : This isn't an error message. "FP" is indicated when freeze prevention is working.

If you see other indications of Status Display, scan the following two-dimensional barcode to see why it is displayed.



In some cases, you may be able to clear the error code by turning the hot water fixtures OFF, then ON again. If the error code still remains, contact the installer or Dux Service Department for assistance.

Contact Dux if:

- Any other error code appears.
- An error code is indicated again after the above actions were followed.
- There are any other questions.

Follow-up Service

Requesting Service

First follow the instructions in the troubleshooting section. (See page 21-23)
If the error is not corrected, contact Dux Service Department at 1300 365 115.

We will need to know:

- **The Model**
Check the data plate (See page 4 for the location of the label)
- **Date of purchase**
See the warranty
- **Details of problem**
Flashing error codes, etc., in much detail as possible
- **Your name, address, and telephone number**
- **Desired date of visit**

Warranty

For repairs after the warranty period, there will be a charge on any service, and service will only be performed if the unit is deemed repairable.
See warranty Document on page 28.

Period of Time for Stocking Repair Parts

Dux will stock repair and maintenance parts for this unit within ten (10) years of the date of original manufacture.

Reinstallation

If you want to reinstall the appliance at a different location, confirm that the gas and power supply indicated on the data plate are available at the new location. If you are not sure, consult the local utility company.

If you move to a region that uses a different type of gas, conversion and adjustment of the appliance will be necessary.

Specifications

- Specifications may be changed without prior notice.
- The capacity may differ slightly, depending on the water pressure, water supply, piping conditions, and water temperature.

Item		Specification						
Model Name	50°C model	26ENG5N	26ENG5L	21ENB5N	21ENB5L	17ENB5N	17ENB5L	
	55°C model	26ENG6N	26ENG6L	21ENB6N	21ENB6L	17ENB6N	17ENB6L	
Type	Installation	Outdoor, Wall mounted						
	Air Supply / Exhaust	Power Flue						
Operating Pressure		200-1,000 kPa						
Minimum Flow Rate		1.5 L/min		2.5 L/min				
Dimensions (Height) × (Width) × (Depth)		520 mm × 350 mm × 170 mm						
Weight		16 kg		15 kg		14 kg		
Water Holding Capacity		0.7 L		0.5 L				
Connection Sizes	Water Inlet	R 3/4 (20 mm)						
	Hot Water Outlet	R 3/4 (20 mm)						
	Gas Inlet	R 3/4 (20 mm)						
Power Supply	Supply	230- 240 VAC (50 Hz)						
	Consumption	NG/ULPG	55.0 W / 60.0 W		36.0 W / 49.0 W		31.0 W / 41.0 W	
		Freeze Prevention	106 W		129 W			
Burner Injector Size	NG	1.45 mm / 2.1 mm		1.2 mm / 2.0 mm		1.2 mm / 1.8 mm		
	ULPG	1.0 mm / 1.4 mm		0.9 mm / 1.4 mm				
Accessories		Anchoring Screws						

Performances

Item		Maximum Performance					
Model Name	50°C model	26ENG5N	26ENG5L	21ENB5N	21ENB5L	17ENB5N	17ENB5L
	55°C model	26ENG6N	26ENG6L	21ENB6N	21ENB6L	17ENB6N	17ENB6L
Gas Consumption		NG	195 MJ/hr		159 MJ/hr		125.5 MJ/hr
		ULPG	195 MJ/hr		159 MJ/hr		127 MJ/hr
Maximum Hot Water Capacity (25°C Rise)		26 L/min		21 L/min		17 L/min	

Maintenance

When water hardness is high, following maintenance (flushing the heat exchanger) is recommended.

1. Disconnect the electrical power to the Water Heater and close the gas supply valve.
2. Close the shutoff valves on both the hot water and cold water lines (V3 and V4).
3. Connect pump outlet hose (H1) to the cold water line at service valve (V2).
4. Connect drain hose (H3) to service valve (V1).
5. Pour chemical product used to flush heat exchanger into water (acid 8-10% of water content like vinegar).
6. Place the drain hose (H3) and the hose (H2) to the pump inlet into the cleaning solution.
7. Open both service valves (V1 and V2) on the hot water and cold water lines.
8. Operate the pump and allow chemical product like vinegar to circulate through the water heater for at least 1 hour at a rate of 15 L/min.
9. Turn off the pump.
10. Rinse the chemical/water from the Water Heater as follows:
 - a. Remove the free end of the drain hose (H3) from the pail. Place in sink or outside to drain.
 - b. Close service valve (V2), and open shutoff valve (V4). Do not open shutoff valve (V3).
 - c. Allow water to flow through the Water Heater for 5 minutes.
 - d. Close shutoff valve (V4). When unit has finished draining remove the inline filter at the cold water inlet and clean out any residue. Place filter back into unit and open valve (V4).
 - e. Close service valve (V1), and open shutoff valve (V3).
11. Disconnect all hose.
12. Reconnect the electrical power to the Water Heater and open the gas supply valve.

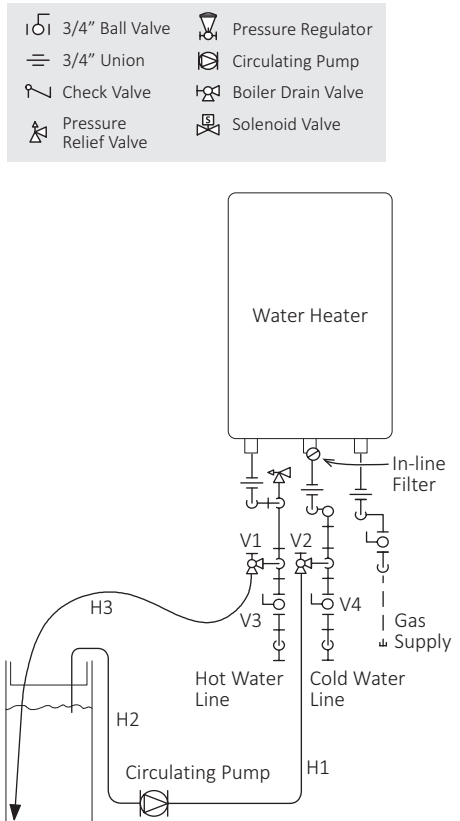



WATER QUALITY

All Dux water heating appliances are constructed from high quality materials and components and all are certified for compliance with relevant parts of Australian and New Zealand gas, electrical and water standards.

Whilst Dux water heaters are warranted against defects, the warranty is conditional upon correct installation and use, in accordance with detailed instructions provided with the heater. In the case of the water supplied to the heater, it is important that the water quality be of acceptable standard.

The water quality limits/parameters listed in water quality table are considered acceptable and generally, Australian and New Zealand suburban water supplies fall within these limits/parameters.

In areas of Australia and New Zealand where water may be supplied, either fully or partly, from bores, artesian wells or similar, one or more of the important limits may will be exceeded and the heater could, therefore, be at risk of failure.

Where uncertainty exists concerning water quality, intending appliance users should seek a water analysis from the water supplying authority and in cases where it is established that the water supply does not meet the quality requirements of the water quality table, the Dux warranty would not apply.

WATER QUALITY TABLE

Maximum levels:

pH	6.5-8.5
Saturation Index (LSI) (langelier)	+0.4 to Minus 1.0 @65C
Total Hardness	200 mg/L
Hardness (as CaCO ₃)	200 mg/L
Chlorides	250 mg/L
Sodium	150 mg/L
Iron	1 mg/L
Silicon Dioxide (SiO ₂)	50 mg/L
TDS	600
Dissolved CO ₂	25 mg/L
Magnesium	10 mg/L



Dux Manufacturing Ltd (Dux) Manufacturer's Warranty

Dux Continuous Flow Water Heater -

Warranty Summary:

Your water heater is specified with a warranty as set out in the table below.

The fault must appear within the defined time period, which commences from the date of installation (or manufacturing date of the unit if proof of the date of installation is not available) in order to be covered.

Dux Continuous Flow Water Heater Warranty		Heat Exchanger	Parts & Labour
Single Family Dwellings	Without recirculation	12 years	3 years
	With recirculation (Temperature set at $\leq 60^{\circ}\text{C}$ and on a timer)	5 years	3 years
All Other Applications		1 year	1 year

The benefits provided to you by this warranty are in addition to any other rights and remedies available to you under the Australian Consumer Law.

Parts and Labour Warranty:

Dux Manufacturing Limited ("Dux") warrants against defects in the water heater arising from faulty materials or workmanship.

During the period (as specified in the table above), Dux will repair or replace any failed component or where necessary, in the absolute discretion of Dux, replace the water heater, free of charge including reasonable labour costs incurred during normal business working hours.

Heat Exchanger Failure Warranty:

Dux warrants against failure of the Heat exchanger, in accordance with its application (as specified in the table above). Conditions apply.

During this period Dux will provide a replacement heat exchanger, free of charge.

Installation and other labour costs are the responsibility of the owner if the water heater is outside parts and labour warranty.

Warranty Conditions:

The warranty only applies to the water heater itself and the components supplied with the water heater by Dux.

The warranty does not cover components supplied by others, including the installer.

The continuous flow failure warranty does not apply if the water heater has been connected to a water supply where the water quality is greater than the quality table on page 27.

These warranties do not apply to defects that are a result of, without limitation, the following:

- failure to install the water heater in accordance with the installation instructions or statutory requirements;
- faulty plumbing or gas supplies including excessive pressure;
- use of the water heater in a manner contrary to this manual or other instructions provided by Dux;
- alterations or repair of the water heater other than by an accredited and licensed service agent or technician;
- accidental damage or abuse.

If the water heater is installed in a position that does not comply with the installation instructions or statutory requirements, then this warranty does not cover major dismantling or removal of cupboards, doors, walls or special equipment and/or excessive labour, at the determination of Dux, to make the water heater accessible for repair or replacement.

Where the Dux water heater is located outside the metropolitan area of a capital city and is more than 100km from a Dux office or Dux agent, the Owner will be responsible under the warranty for paying the costs of transporting the water heater and or any component in the water heater to and from an approved Dux agent or Dux office (including any insurance associated with that transport), or paying the travelling time of an approved Dux agent to and from the owners premises.



Commencement of Warranty:

The warranty period commences from the date of installation of the water heater. Where proof of the date of installation is not available, the warranty period commences on the date of manufacture of the water heater. This is shown on the compliance plate on the outside of the water heater.

The replacement of the water heater, or a component of it, under this warranty does not change the warranty commencement date.

The original commencement date continues to apply.

Consequential Losses:

Claims for damage to furniture, carpets, walls, foundations or any other consequential loss either directly or indirectly due to defects of any kind in the water heater will only be met by Dux where the damage could be considered reasonably foreseeable and the water heater was installed in accordance with the installation instructions and all relevant statutory requirements.

The Australian Consumer Law ("ACL"):

Our goods come with guarantees that cannot be excluded under the Australian Consumer Law. You are entitled to a replacement or refund for a major failure and compensation for any other reasonably foreseeable loss or damage. You are also entitled to have the goods repaired or replaced if the goods fail to be of acceptable quality and the failure does not amount to a major failure.

If Dux fails to meet a guarantee under the ACL, your remedy for such failure may be limited to any one or more of the following:

- replacement of the water heater;
- repair of the water heater;
- refunding the cost of the water heater;
- payment of the reasonable costs of having the water heater repaired; payment in respect of the reduced value of the water heater.

How to Make a Warranty Claim:

Warranty claims can be placed by completing the following steps:

- Contact Customer Service on 1300 365 115 (in Australia) or 0800 729 389 (in New Zealand).
- Provide the serial number and model number of the water heater. This can be found on the compliance plate on the outside of the water heater.
- Provide your full name, address and contact number.
- Provide proof of date of installation for warranty to commence from that date, rather than from the date of manufacture. See Commencement of Warranty on page 28.

Please note, if the defect or fault is not covered by the warranty or guarantee, you will be responsible for the costs incurred by the service agent or technician.

Contact Details:

Dux Manufacturing Limited
Lackey Road
Moss Vale, NSW, 2577
Australia
1300 365 115 (Australia)
0800 729 389 (New Zealand)
Email: duxaftersales@dux.com.au

Our goods come with guarantees that cannot be excluded under the Australian Consumer Law. You are entitled to a replacement or refund for a major failure and for compensation for any other reasonably foreseeable loss or damage. You are also entitled to have the goods repaired or replaced if the goods fail to be of acceptable quality and the failure does not amount to a major failure.



Note



Note

