



# Owner's Manual

## ***proflo***<sup>®</sup>

### **Electric Storage Water Heaters**

#### **Standard Models:**

80T118, 80T124, 80T136, 125T118, 125T136,  
125X118, 125X136, N135T118, N135T130,  
160T124, 160T136, 180TD124, 180TD130,  
180ST124, 180ST130, 250T118, 250T136,  
N250T124, N250T130, N300T124, N300T130,  
315T136, 315T236, 315T248, 400T136, 400T236

An 'H' at the end of the model number indicates that the water heater is fitted with a hard-water anode.

#### Installation Details

#### Owner's Information

#### Warranty

For advice, repairs and service, call:

1300 365 115 (Australia)

0800 729 389 (New Zealand)



Carefully remove all packaging and transit protection from the heater before installation. Dispose of the packaging responsibly using re-cycling facilities where they exist.



Specifications and materials may change without notice.

Effective for the above model numbers of Proflo electric storage water heaters manufactured and sold after 1st September 2021.



## Important Safety Information

**WARNING – THIS APPLIANCE MAY DELIVER WATER AT HIGH TEMPERATURE. REFER TO THE PLUMBING CODE OF AUSTRALIA (PCA), LOCAL REQUIREMENTS AND INSTALLATION INSTRUCTIONS TO DETERMINE IF ADDITIONAL DELIVERY TEMPERATURE CONTROL IS REQUIRED.**

**WARNING – FOR CONTINUED SAFETY OF THIS APPLIANCE IT MUST BE INSTALLED, OPERATED AND MAINTAINED IN ACCORDANCE WITH THE MANUFACTURER'S INSTRUCTIONS.**

This water heater is not intended for use by persons (including children) with reduced physical, sensory or mental capabilities, or lack of experience and knowledge, unless they have been given supervision or instruction concerning use of the water heater by a person responsible for their safety.

Children should be supervised to ensure they do not interfere with the water heater. Ensure animals are supervised so they do not interfere with the water heater.

**DO NOT STORE CHEMICALS OR FLAMMABLE MATERIALS, OR SPRAY AEROSOLS NEAR THIS WATER HEATER.**

**DO NOT STORE ANY FLAMMABLE OR COMBUSTIBLE MATERIALS ON OR WITHIN 1 METRE OF THE WATER HEATER.**

**DO NOT PLACE ARTICLES ON OR AGAINST THE WATER HEATER**

**DO NOT MODIFY THIS WATER HEATER.**

**DO NOT OPERATE THE WATER HEATER WITH ANY PANELS OR COVERS REMOVED.**

If the water heater is not used for two weeks or more, a quantity of hydrogen (which is highly flammable) may accumulate inside the water heater tank.

To dissipate this gas safely it is recommended that a hot tap be turned on for several minutes at a sink, basin or bath, but not a dishwasher, clothes washer or other appliance.

During this procedure there must be no smoking, open flame or any other electrical appliance operating nearby. If hydrogen is discharged through the tap it will probably make a sound similar to air escaping.

### **RELIEF VALVE:**

The Pressure & Temperature Relief (PTR) Valve must be installed directly into the RP $\frac{1}{2}$ " (DN15) socket marked "RELIEF VALVE".

The PTR Valve rating is 1,400 kPa and 10 kW on 80L, 125L and 160L capacities. The PTR Valve rating is 1,000 kPa and 10 kW on 135L, 180L, 250L, 300L, 315L and 400L capacities.

The valve must not be tampered with or removed. The water heater must not be operated unless this valve is fitted and in working order.

The drain line from the PTR Valve must be installed in a continuously downward direction in a frost free environment.

The PTR Valve is to be operated regularly to remove lime deposits and to verify it is not blocked. The drain line fitted to the PTR Valve must be left open to the atmosphere.



# Important Safety Information

**DANGER – FAILURE TO OPERATE THE PTR VALVE EASING LEVER AT LEAST ONCE EVERY SIX MONTHS MAY RESULT IN THE WATER HEATER EXPLODING. CONTINUOUS LEAKAGE OF WATER FROM THE VALVE MAY INDICATE A PROBLEM WITH THE WATER HEATER.**

The PTR Valve should be checked by a licensed tradesperson for adequate performance, or replaced at intervals not exceeding 5 years, or less in areas where local regulations apply.

It is normal for water to drip from the drain line fitted to the PTR Valve during heating cycles.

Continuous leakage of water from the PTR Valve may indicate a problem with the water heater. This may be caused by excessive water supply pressure, a faulty PTR Valve or a faulty thermostat.

Turn off the water heater and contact Dux After Sales and Service.

## **OVER-TEMPERATURE ENERGY CUT-OUT:**

The operation of the over-temperature energy cut-out indicates a possibly dangerous situation. Do NOT reset the over-temperature energy cut-out until the water heater has been serviced by a licensed tradesperson.

## **ELECTRICAL SAFETY:**

This water heater is designed for single phase 230 - 240V a.c. supply only. The electrical connection must comply with Local Supply Authority Regulations and AS/NZS 3000 (known as the Wiring Rules). A means for disconnection must be incorporated in the fixed wiring in accordance with the Wiring Rules.

Any electrical covers should be removed only by a licensed tradesperson, and only after the electrical supply to the water heater has been isolated.

**When the supply wiring has been connected, ensure the wires are kept lower than the terminal block.**

Excess wire is not to be looped close to the thermostat or tank.

In addition to the Pressure & Temperature Relief Valve, electric storage water heaters are fitted with a combination thermostat and over-temperature energy cut-out.

This device must not be tampered with or removed. Replacement of this device must only be carried out by a licensed tradesperson or the manufacturer.

The water heater must not be operated unless this device is fitted and in working order.

## **COLD WATER CONNECTION:**

The water heater is intended to be permanently connected to the water supply main, and not connected by a hose-set.

This water heater is designed for direct connection to water supply pressures of up to 1,120 kPa on 80L, 125L and 160L capacities and 800 kPa on 135L, 180L, 250L, 300L, 315L and 400L capacities.

Where the mains pressure can exceed or fluctuate beyond this pressure, a pressure reducing valve must be fitted in the cold water inlet supply.

Instructions explaining how the water heater can be drained can be found on page 6.



# Important Safety Information

## INSTALLATION REQUIREMENTS

### GENERAL:

This water heater must be installed by a licensed tradesperson, and in accordance with:

- In Australia, the Plumbing Code of Australia (PCA);
- In New Zealand, Clause G12 of the New Zealand Building Code (NZBC);
- AS/NZS 3000 Electrical Installations (known as the Australian / New Zealand Wiring Rules); and
- Local authority regulations.

Outside Australia and New Zealand, please refer to local plumbing and building codes and regulations.

Failure to comply with these requirements may affect the warranty.

AS/NZS 3500.4 Plumbing and Drainage – Heated Water Services provides a Deemed-to-Satisfy Solution for the PCA and a Verification Method for Clause G12 of the NZBC. Other methods of compliance are available. Dux recommends that installations conform with AS/NZS 3500.4.

### NOTE FOR VICTORIA:

This water heater must be installed by a licensed person as required by the Victorian Building Act (1993).

Only a licensed person will provide a compliance certificate, showing that the work complies with all the relevant Standards. Only a licensed person will have insurance protecting their workmanship.

### LOCATION:

The water heater should be located as close as possible to the most frequently used hot water outlet.

Ensure the compliance plate and associated warnings are clearly visible. The water heater must be accessible without the use of a ladder or scaffold. Adequate clearance must be available for service to the element, thermostat, relief valve and anode. All models are equipped with a sacrificial anode, allow half of the height of the water heater to provide access through the top cover.

Electric storage water heaters may be installed indoors. A properly drained safe tray must be installed where property damage could occur from water spillage. Refer to AS/NZS 3500.4 for further information.

Refer to local regulations before installing the water heater in a roof space.

### WATER HEATER SUPPORT:

The water heater must be installed on a flat, solid supporting surface. The pipework must not be used to support the water heater.

Where the water heater is subjected to wet conditions, a plinth should be installed under the water heater.

### POOL HEATING:

This water heater must **not** be used for pool heating.



# Contents

Important Safety Information	i
Installation Requirements	iii
Plumbing Connections	2
Specifications	4
Filling and Draining	6
Electrical Connection	7
System Maintenance	8
Considering a Service Call?	9
Warranty	10



# Plumbing Connections

## Relief Valve:

The Pressure & Temperature Relief (PTR) Valve is supplied either inside the electrical cover of the water heater or in a bag attached to the water heater. Instructions on how to remove the electrical cover can be found on page 7. Discard the packaging containing the PTR Valve and brass plugs.

The PTR Valve rating depends on the size of the water heater. See Specifications on page 4 for details.

The PTR Valve rating is also shown on the compliance plate. The PTR Valve must be installed directly into the RP $\frac{1}{2}$ "(DN15) socket marked "RELIEF VALVE" at the top of the water heater. Ensure that a sealing material is applied to the PTR Valve to prevent water leaks.

The drain line from the PTR Valve must be made of copper and run in accordance with the requirements of AS/NZS 3500.4. It must be installed in a continuously downward direction in a frost free environment.

The PTR Valve and its drain line must not be sealed or blocked. Generally a separate drain line must be run for the valve although it may be joined with the drain line from the expansion control valve under certain circumstances.

The PTR valve must be insulated with the PTR insulation supplied with the heater.

Care must be taken when attaching pipe saddles to the water heater. Self-drilling screws no longer than 12 mm are recommended.

It is normal for the valve to leak a small amount of water during heating cycles.

The PTR Valve is not intended to enable connection of the water heater to supplementary energy sources such as solar panels or slow combustion stoves. Refer to

AS/NZS 3500.4 for guidance on these types of installations.

## Hot Water Connection:

The hot water pipe is to be connected to a RP $\frac{3}{4}$ "(DN20) socket marked "OUTLET" at the top of the water heater.

On dual handed models, the unused socket marked "OUTLET" is to be plugged with one of the brass plugs supplied. Ensure that a sealing material is applied to the brass plug to prevent water leaks.

It is recommended that all hot water pipes are insulated. Hot water pipes installed outdoors should be insulated with UV stabilised insulation.

Plastic pipes or fittings shall not be used within 1 metre of the outlet although they may be used downstream of a temperature control valve. Refer to AS/NZS 3500.4 for further details.

## Temperature Protection:

Water heaters can produce very hot water. To reduce the risk of scald injury, it is mandatory under the requirements of AS/NZS 3500.4 that an approved temperature control device is fitted to the hot water supply to outlets used primarily for personal hygiene. This device should be checked at regular intervals to ensure its operation and settings remain correct.

## Water Supply:

This water heater has been manufactured to suit the water conditions of most Australian and New Zealand metropolitan supplies.

Please note certain water supplies can have a detrimental effect on the water heater and its life expectancy. If you are unsure about the water supply, you can obtain information from the local water supply authority.



## Plumbing Connections

The water heater is designed for use in areas where the Total Dissolved Solids (TDS) content of the water supply is less than 2500 mg/L. The Tank Failure Warranty does not apply in areas where the TDS exceeds 2500 mg/L.

In areas where the TDS exceeds 600 mg/L, it is possible the magnesium alloy anode (supplied in standard water heaters) may become over-reactive. To alleviate this, a hard water model is recommended, or the magnesium alloy anode should be replaced with an aluminium alloy anode. Aluminium alloy anodes are available from your local Dux Supplier.

Water can also be very corrosive, the measure of this is the saturation index. If the water saturation index is greater than 0.40, an expansion control valve should be fitted. If the index is greater than 0.80, the electrical heating element should be replaced with a low power density Incoloy heating element. Please consult Dux After Sales and Service for advice if required.

### **Cold Water Connection:**

The water heater is intended to be permanently connected to the water supply main, and not connected by a hose-set.

An approved isolating valve, non-return valve, line strainer (optional but recommended) and union must be fitted between the water supply main and a RP $\frac{3}{4}$ "(DN20) socket marked "INLET" at the bottom of the water heater. See the diagram on page 6 for details.

On dual handed models, the unused socket marked "INLET" is to be plugged with one of the brass plugs supplied. Ensure that a sealing material is applied to the brass plug to prevent water leaks.

All fittings must be approved by the relevant Authority. Plastic pipes or fittings shall not be used between the isolating valve and the inlet.

### **Water Supply Pressure:**

This water heater is designed for direct connection to water supply pressures of up to 1,120 kPa for 80L, 125L and 160L models, and 800 kPa for 135L, 180L, 250L, 300L, 315L and 400L capacities.

Where the mains pressure can exceed or fluctuate beyond this pressure, a pressure reducing valve must be fitted in the cold water inlet supply.

### **Note for New Zealand, South Australia and Western Australia:**

It is a requirement in these locations that an expansion control valve be fitted on the cold water supply line between the non-return valve and the water heater.



# Specifications

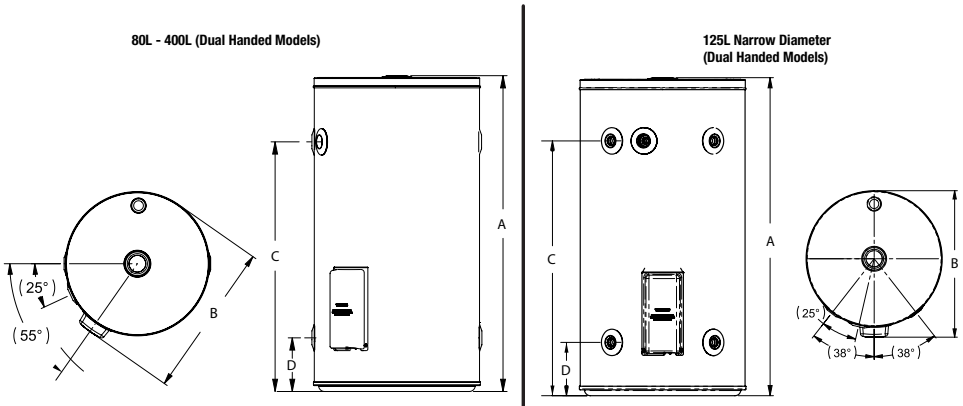

## Nominal Dimensions (mm)

Model	80T1	125T1	125X1	160T1	250T1	315T1/ 315T2	400T1/ 400T2
Total Height (A)	925	1090	1300	1315	1445	1765	1705
Total Diameter (B)	490	530	490	530	620	620	705
Outlet Height (C)	735	865	1115	1095	1210	1530	1445
Inlet Height (D)	160	190	160	190	195	195	220
Connections	90°	90°	V-Fit	90°	90°	90°	90°

## Specifications

Tank Size	80T1	125T1	125X1	160T1	250T1	315T1	315T2	400T1	400T2
Storage Capacity (L)	88	130	132	163	259	321	321	415	415
Hot Water Delivery (L)	80	125	125	160	250	315	315	400	400
Twin Element Boost (L)	–	–	–	–	–	–	50	–	80
Net Weight Empty (kg)	41	51	54	59	72	93	93	115	115
Element(s) Sizes (kW)	1.8, 2.4, 3.6	1.8, 3.6	1.8, 3.6	2.4, 3.6	1.8, 3.6	3.6	2 × 3.6 or 2 × 4.8	3.6	2 × 3.6

### Relief Valve:

Pressure (kPa)	1400	1400	1400	1400	1000	1000	1000	1000	1000
Temperature (°C)	99								
Power Rating (kW)	10kW								





# Specifications

**N135T1 & 180TD1**

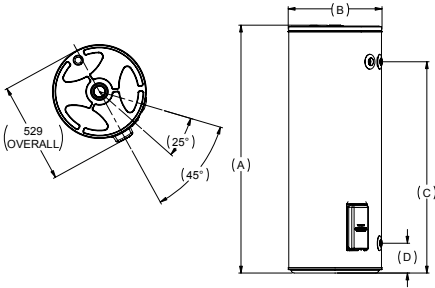

**180ST, N250T1 & N300T1**

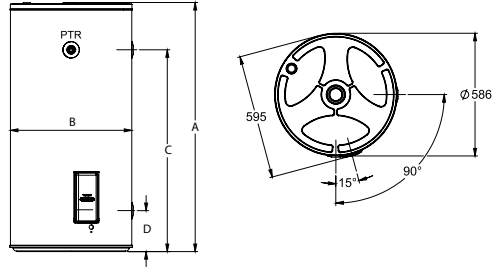

Nominal Dimensions (mm)		
Model	N135T1	180TD1
Total Height (A)	1298	1776
Total Diameter (B)	492	492
Outlet Height (C)	1106	1574
Inlet Height (D)	156	156

Nominal Dimensions (mm)			
Model	180ST	N250T1	N300T1
Total Height (A)	1190	1566	1804
Total Diameter (B)	580	580	580
Outlet Height (C)	964	1342	1580
Inlet Height (D)	196	196	196

Specifications		
Model	N135T1	180TD1
Storage Capacity (L)	131	183.5
Net Weight Empty (kg)	50	65
Element(s) Sizes (kW)	1.8, 3.0	2.4, 3.0
<b>Relief Valve:</b>		
Pressure (kPa)	1000	1000
Temperature (°C)	99	
Power Rating (kW)	10kW	

Specifications			
Model	180ST	N250T1	N300T1
Storage Capacity (L)	183.5	250	291
Net Weight Empty (kg)	60	77	94
Element(s) Sizes (kW)	2.4, 3.0	2.4, 3.0	2.4, 3.0
<b>Relief Valve:</b>			
Pressure (kPa)	1000	1000	1000
Temperature (°C)	99		
Power Rating (kW)	10kW		



# Filling and Draining

## Filling the Water Heater:

The water heater must be filled with water before turning on the electrical supply.

1. Open all hot water taps.
2. Open the isolating valve at the cold water inlet slowly and allow the water heater to fill until water flows through the system.
3. Close each hot water tap after the air is expelled from its line.
4. Open the Pressure & Temperature Relief Valve for approximately 10 seconds by lifting the easing lever on the valve. Confirm water is relieved to waste through the relief valve drain pipe.
5. Lower the lever gently and check it closes correctly.

## Draining the Water Heater:

1. Turn off the electricity supply to the water heater.
2. Turn off the cold water supply to the water heater at the isolating valve.
3. Gently operate the easing lever on the Pressure & Temperature Relief (PTR) Valve to release the pressure in the water heater.
4. Disconnect the cold water inlet union and attach a drain hose to the water heater.
5. Gently operate the easing lever on the PTR Valve to let air into the water heater and allow water to escape through the hose.

## Cold Water Connection Diagram:

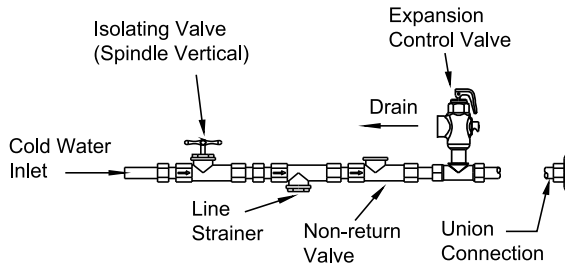

Note: a combined isolating valve/non-return valve/line strainer may be used.

The expansion control valve is only required where local regulations demand, although it is recommended in areas where the water saturation index is greater than 0.40.



# Electrical Connection

### General:

This water heater is designed for single phase 230 - 240V a.c. supply only. The electrical connection must comply with Local Supply Authority Regulations and AS/NZS 3000.

Connection of the electrical wiring must only be carried out by a licensed tradesperson.

Connections are made at the terminal block under the water heater electrical cover. A means for disconnection must be incorporated in the fixed wiring in accordance with the Wiring Rules.

### Removing the Electrical Cover:

Before removing the electrical cover, ensure the electrical power supply is safely isolated.

The electrical cover is removed by undoing the two screws at the bottom of the cover and sliding the cover downwards to disengage the top edge.

### Connections:

The cable entry is a pre-punched hole designed to accept a 20 mm conduit gland. It is located adjacent to the terminal block.

To prevent damage to the wiring, the cable entry must be fitted with a gland prior to feeding the wiring through the hole. Ensure the conduit entry is sealed correctly.

Connect the active and neutral wires to the terminal block and the earth wire to the earth tab (located on the right hand side). Excess wire is not to be looped close to the thermostat or tank.

### Replacing the Electrical Cover:

1. Press the reset button on the thermostat to ensure the over-temperature energy cut-out is set.
2. If supplied inside the electrical cover, ensure that the Pressure & Temperature Relief Valve, both of the brass plugs, and their clear plastic packaging have been removed from inside the cover.
3. Slide the cover up, ensuring the top edge engages under the case.
4. Swing the cover down until the bottom edge contacts the case. Ensure the terminal block mounting plate is below the pins located inside the cover.
5. Refit & tighten both screws in the cover.

**Ensure the water heater is filled with water before turning on the electricity supply.**

### SINGLE ELEMENT ELECTRIC

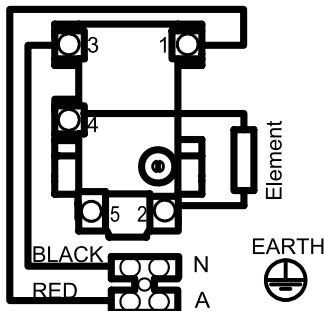

### TWIN ELEMENT ELECTRIC

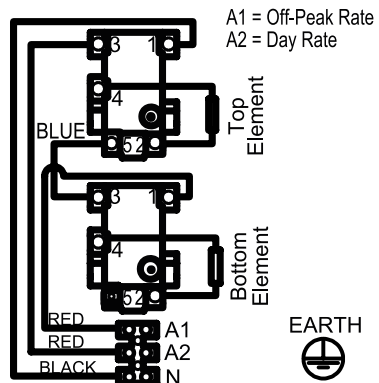



## System Maintenance

Regular servicing will help to extend the life of the water heater, and keep it operating safely and efficiently.

Your water heater warranty is not conditional on completing the regular servicing recommended in this manual.

The conditions applying to your water heater warranty are set out on page 10 of this manual.

### Six Month Service:

This service may be carried out by the owner.

1. Stand clear of the Pressure & Temperature Relief (PTR) Valve drain pipe outlet.
2. Open the PTR Valve for approximately 10 seconds by lifting the easing lever on the valve. Confirm water discharges to waste through the drain pipe.
3. Lower the easing lever gently and check it closes correctly.
4. Repeat the above process for the expansion control valve (if installed).

Other than this, personally inspecting or servicing any part of the water heater is not recommended.

### Five Year Service:

This service should only be carried out by a licensed tradesperson. We recommend your local Dux Service Agent.

In locations where the water has Total Dissolved Solids (TDS) exceeding 600 mg/L, this service is recommended every 3 years.

This service should include the following:

- Replace the PTR Valve.
- Replace the anode.
- Inspect and flush the expansion control valve (if installed).
- Drain and flush the water heater.
- Inspect the condition of the electrical conduit and the water heater electrical cover. Replace any damaged components.

Replacement parts are available from your local Dux supplier.



## Considering a Service Call?

It is recommended that the following points be reviewed before making a service call:

### **No Hot Water:**

Ensure the power supply circuit breaker has not “tripped”. If the water heater is on a timed tariff such as off-peak, ensure this is operating correctly.

### **High Energy Bills or Insufficient Hot Water:**

- Often the hot water usage of showers, washing machines and dishwashers can be under estimated. Review these appliances to determine if the daily usage is greater than the capability of the water heater.
- If necessary check the shower flow rates with a bucket, measuring the amount of water used over a period of time. If it is not possible to adjust water usage patterns, an inexpensive flow control valve can easily be fitted to the shower outlet.
- Is the water heater the correct size for the requirements? Sizing details are available from your Dux supplier.
- Is there a leaking hot water pipe or dripping hot water tap? A small leak can waste a large quantity of hot water. Replace faulty tap washers and arrange for your plumber to rectify any leaking pipe work.
- Is the Pressure & Temperature Relief Valve discharging too much water? See below.

### **Continuous Trickle of Water from Pressure & Temperature Relief (PTR) Valve:**

This is most likely due to a build up of foreign matter. In this case, try gently raising the easing lever on the PTR Valve for a few seconds, then release gently.

This may dislodge a small particle of foreign matter and rectify the fault.

### **Water Discharge from PTR Valve:**

It is not unusual for a small quantity of water to discharge during the heating of water in the storage tank. The amount of discharge will depend on hot water usage and the size of the storage tank.

As a guide, it will discharge about 2% of the volume of the water heated.

Continuous leakage of water from the PTR Valve may indicate a problem with the water heater. Turn off the water heater and contact Dux After Sales and Service.

***If after checking the above points, the problem has not been identified, please contact Dux After Sales and Service.***



# Warranty

## Dux Electric Storage Water Heater - Warranty Summary:

Your water heater is specified with a warranty as set out in the table below.

The fault must appear within the defined time period, which commences from the date of installation (or manufacturing date of the unit if proof of the date of installation is not available) in order to be covered.

## Dux Proflo Water Heater Warranty

Dux Proflo 80L – 400L Water Heater Warranty	Tank Warranty	Parts & Labour
<b>Single Family Dwelling</b>	10 years	1 year
<b>All Other Applications</b>	3 years	1 year

The benefits provided to you by this warranty are in addition to any other rights and remedies available to you under the Australian Consumer Law.

### Parts and Labour Warranty:

Dux Manufacturing Limited (“Dux”) warrants against defects in the water heater arising from faulty materials or workmanship.

During the period (as specified in the table above), Dux will repair or replace any failed component or where necessary, in the absolute discretion of Dux, replace the water heater, free of charge including reasonable labour costs incurred during normal business working hours.

### Tank Failure Warranty:

Dux warrants against failure of the storage tank, in accordance with its application (as specified in the table above). Conditions apply.

During the first year of warranty, Dux will provide a replacement water heater free of charge including installation and labour costs.

Installation and other labour costs are the responsibility of the owner if the water heater is outside parts and labour warranty.

## Warranty Conditions:

The warranty only applies to the water heater itself and the components supplied with the water heater by Dux. The warranty does not cover components supplied by others, including the installer.

The tank failure warranty does not apply if the water heater has been connected to a water supply where the Total Dissolved Solids content is greater than 2500 mg/L.

These warranties do not apply to defects that are a result of, without limitation, the following:

- failure to install the water heater in accordance with the installation instructions or statutory requirements;
- faulty plumbing or water supply including excessive pressure;
- faulty power supply;
- use of the water heater in a manner contrary to this manual;
- alterations or repair of the water heater other than by a suitably qualified tradesperson;
- accidental damage or abuse.

If the water heater is installed in a position that does not comply with the installation instructions or statutory requirements, then this warranty does not cover major dismantling or removal of cupboards, doors, walls or special equipment and/or excessive labour, at the determination of Dux, to make the water heater accessible for repair or replacement.

Where the Dux water heater is located outside the metropolitan area of a capital city and is more than 100km from a Dux office or Dux agent, the Owner will be responsible under the warranty for paying the costs of transporting the water heater and or any component in the water heater to and from an approved Dux agent or Dux office (including any insurance associated with that transport), or paying the travelling time of an approved Dux agent to and from the owners premises.



# Warranty

## Commencement of Warranty:

The warranty period commences from the date of installation of the water heater. Where proof of the date of installation is not available, the warranty period commences on the date of manufacture of the water heater. This is shown on the compliance plate on the outside of the water heater.

The replacement of the water heater, or a component of it, under this warranty does not change the warranty commencement date. The original commencement date continues to apply.

## Exclusion and Limitation of Liability:

In addition to any other provisions set out in this document and to the maximum extent permitted by any applicable law or regulation, Dux will not be liable for any claim:

1. for consequential loss to any property arising directly or indirectly out of or connected to the installation of the water heater. This includes but is not limited to furnishings, carpets, foundations, housing effects and buildings.
2. for any direct or indirect economic or financial loss of any nature.
3. arising out of or connected to a water heater that has been resold or moved from its original installation location.
4. arising out of or connected to any misuse, or other use, installation or maintenance that is not in accordance with the procedures and requirements set out in this document.

To the extent permitted by law the liability of Dux shall be limited to the cost of the repair or replacement of the water heater.

## The Australian Consumer Law (“ACL”):

*Our goods come with guarantees that cannot be excluded under the Australian Consumer Law. You are entitled to a replacement or refund for a major failure and compensation for any other reasonably foreseeable loss or damage. You are also entitled to have the*

*goods repaired or replaced if the goods fail to be of acceptable quality and the failure does not amount to a major failure.*

If Dux fails to meet a guarantee under the ACL, your remedy for such failure may be limited to any one or more of the following:

- replacement of the water heater;
- repair of the water heater;
- refunding the cost of the water heater;
- payment of the reasonable costs of having the water heater repaired;
- payment in respect of the reduced value of the water heater.

## How to Make a Warranty Claim:

Warranty claims can be placed by completing the following steps:

- Contact Dux on one of the numbers listed below.
- Select the “Service” option followed by the “Hot Water” option.
- Provide the serial number and model number of the water heater. This can be found on the compliance plate on the outside of the water heater.
- Provide your full name, address and contact number.
- Provide proof of date of installation for warranty to commence from that date, rather than from the date of manufacture. See Commencement of Warranty on page 11.

Please note, if the defect or fault is not covered by the warranty or guarantee, you will be responsible for the costs incurred by the service agent or technician.

## Contact Details:

Dux Manufacturing Limited  
Lackey Road, Moss Vale, NSW, 2577  
Australia

1300 365 115 (Australia)

0800 729 389 (New Zealand)

Email: [duxaftersales@dux.com.au](mailto:duxaftersales@dux.com.au)

# proflo®

## Electric Storage Water Heaters

For advice, repairs and service, call:

1300 365 115 (Australia)

0800 729 389 (New Zealand)

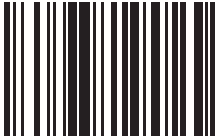

H0421

### Please Register Your Water Heater



Please take a moment to fill out your details for warranty registration at:

[www.dux.com.au/warranty](http://www.dux.com.au/warranty)

or use your smartphone to scan this code:



This will ensure all your current details are registered with us for prompt warranty service if required.

To view our privacy policy please visit <http://www.dux.com.au/privacy>

Date of Installation: .....

Installer's Name: .....

Installer's Company: .....

Installer's Licence No: .....

Installer's Signature: .....

Serial Number